

# QUARTZ KITCHEN SINK

**Q STONEX**  
Elevate with Quartz Excellence

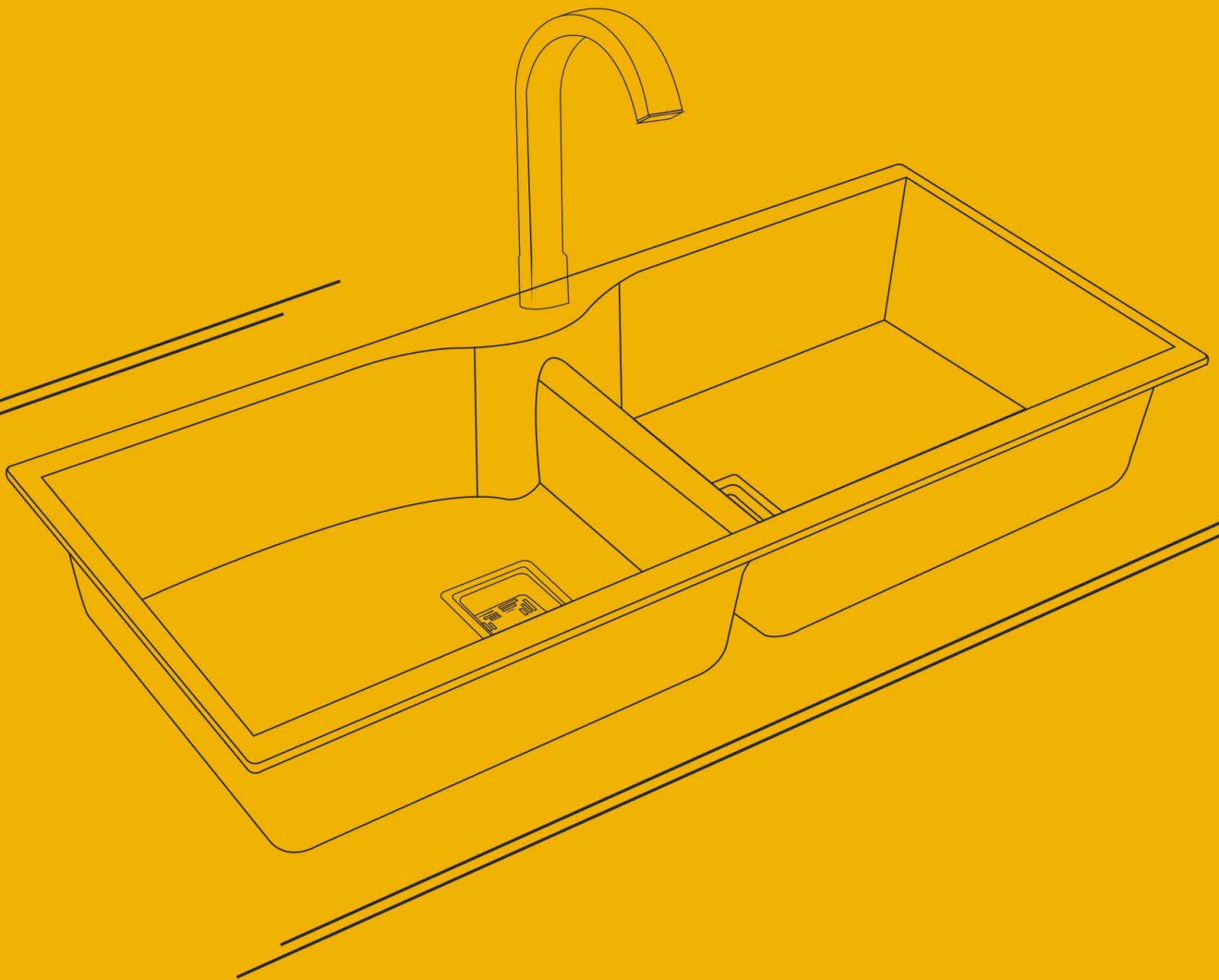

[www.quartzstonex.com](http://www.quartzstonex.com)

THE  
**FUTURE**  
IS HERE

# // Q STONEX

Elevate with Quartz Excellence



THE  
**FUTURE**  
IS HERE

Q stonex continuously endeavors to maintain exacting international standards of procurement, production and quality testing.

# // Q STONEX

Elevate with Quartz Excellence

## COMPANY PROFILE

### Q STONEX NOW ENTERS THE WORLD OF EXCLUSIVE QUARTZ KITCHEN SINK PRODUCT

Welcome to the beautiful World of Q STONEX Exclusive Quartz Kitchen Sink Products.

Q Stonex Sink is stepping towards becoming a global hi-tech manufacturer of premium composite quartz (granite and metallic) kitchen sink. We offer wide range of quartz kitchen sink.

A Sink has an important role to play in the kitchen's style statement. It has not only to function as culinary pit shop but at the same time to enhance the function and synthetic of modern kitchen.

Q StoneX continuously endeavours to maintain exacting international standards of procurement, production and quality testing. The modern testing facilities are equipped to qualify every Sink by its length, thickness, straightness, shape and surface.

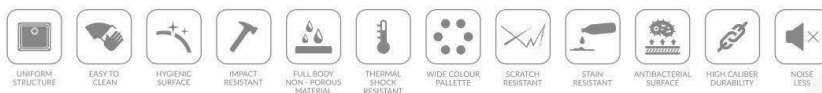

# // Q STONEX

Elevate with Quartz Excellence

## GRAPHITO

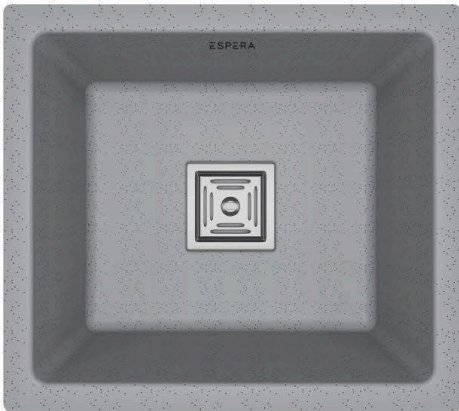

### SPECIFICATION

SIZE : 16 X 18 X 8 inch  
406 X 457 X 213 mm

### WEIGHT

8.0 Kg. (Approx)

### M.R.P.

Granite : 5395/-  
Metallic : 6495/-

 **10 MM**  
THICKNESS

SINGLE  
BOWL SINK



DIMENSION SIZE

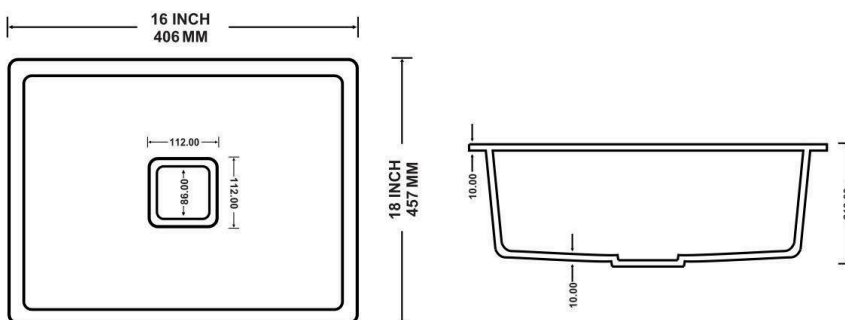

THE  
**FUTURE**  
IS HERE



# // Q STONEX

Elevate with Quartz Excellence

## FLATRON

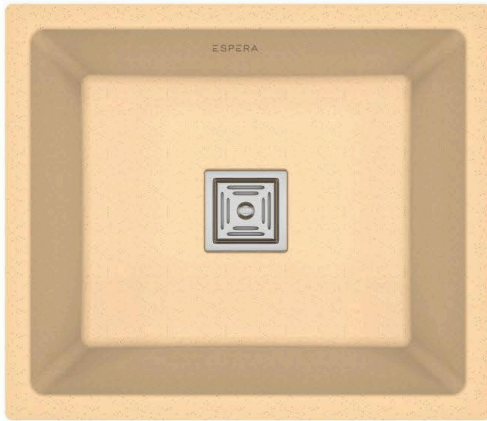

### SPECIFICATION

SIZE : 21 X 18 X 8 inch  
533 X 457 X 213 mm

### WEIGHT

10.0 Kg. (Approx)

### M.R.P.

Granite : 6595/-  
Metallic : 7895/-

 **10 MM**  
THICKNESS

SINGLE  
BOWL SINK



DIMENSION SIZE

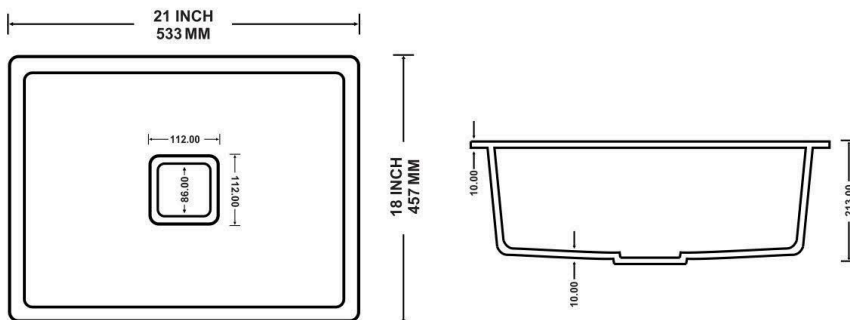

# // Q STONEX

Elevate with Quartz Excellence

## CRYSTO

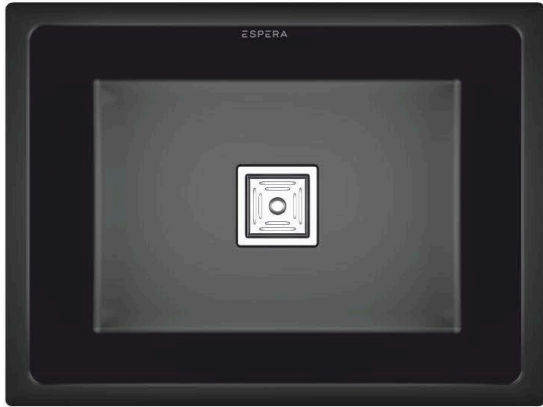

**SPECIFICATION**  
SIZE : 24 X 18 X 8 inch  
609 X 457 X 213 mm

**WEIGHT**  
11.5 Kg. (Approx)

**M.R.P.**  
Granite : 6995/-  
Metallic : 8695/-

▽ 10 MM  
▲ THICKNESS

SINGLE  
BOWL SINK



DIMENSION SIZE

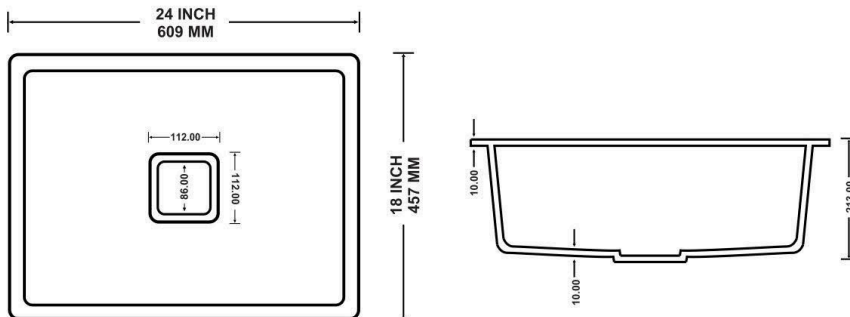

THE  
**FUTURE**  
IS HERE





# // Q STONEX

Elevate with Quartz Excellence

## PLATINIUM

**SPECIFICATION**  
SIZE : 36 X 18 X 8 inch  
915 X 450 X 208 mm

**WEIGHT**  
16 Kg. (Approx)

**M.R.P.**  
Granite : 12299/-  
Metallic : 14799/-



DRAIN BOARD  
SINK

▽ 09MM  
▲ THICKNESS



DIMENSION SIZE

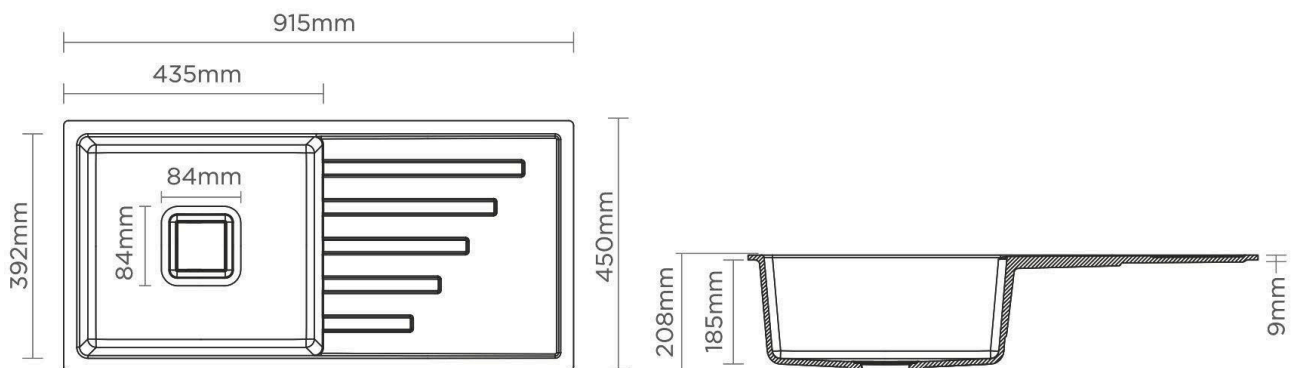

THE  
**FUTURE**  
IS HERE



# // Q STONEX

Elevate with Quartz Excellence

## MARVEL



### SPECIFICATION

SIZE : 45 X 20 X 9 inch  
1143 X 508 X 236 mm

### WEIGHT

27 Kg. (Approx)

### M.R.P.

Granite : 17199/-  
Metallic : 19399/-

10 MM  
THICKNESS

DOUBLE  
BOWL SINK



DIMENSION SIZE

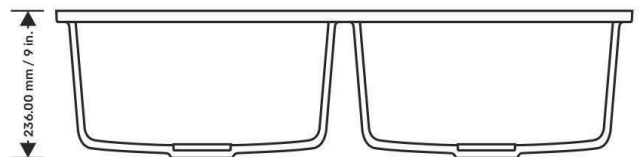
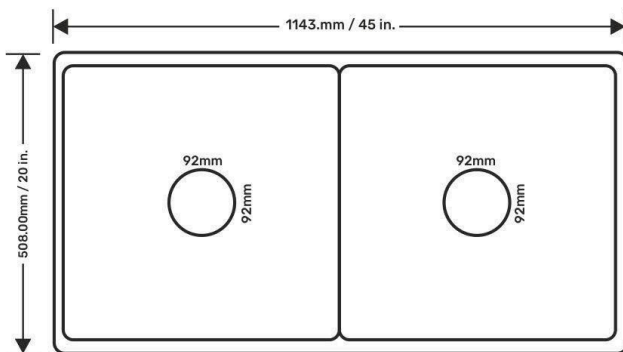

THE  
**FUTURE**  
IS HERE



## Features of Quartz Kitchen Sink



UNIFORM  
STRUCTURE



EASY TO  
CLEAN



HYGIENIC  
SURFACE



IMPACT  
RESISTANT



FULL BODY  
NON - POROUS  
MATERIAL



THERMAL  
SHOCK  
RESISTANT



WIDE COLOUR  
PALLETTE



SCRATCH  
RESISTANT



STAIN  
RESISTANT



ANTIBACTERIAL  
SURFACE



HIGH CALIBER  
DURABILITY



NOISE  
LESS

## Installation



TOP  
MOUNT



UNDER  
MOUNT



FLUSH  
MOUNT

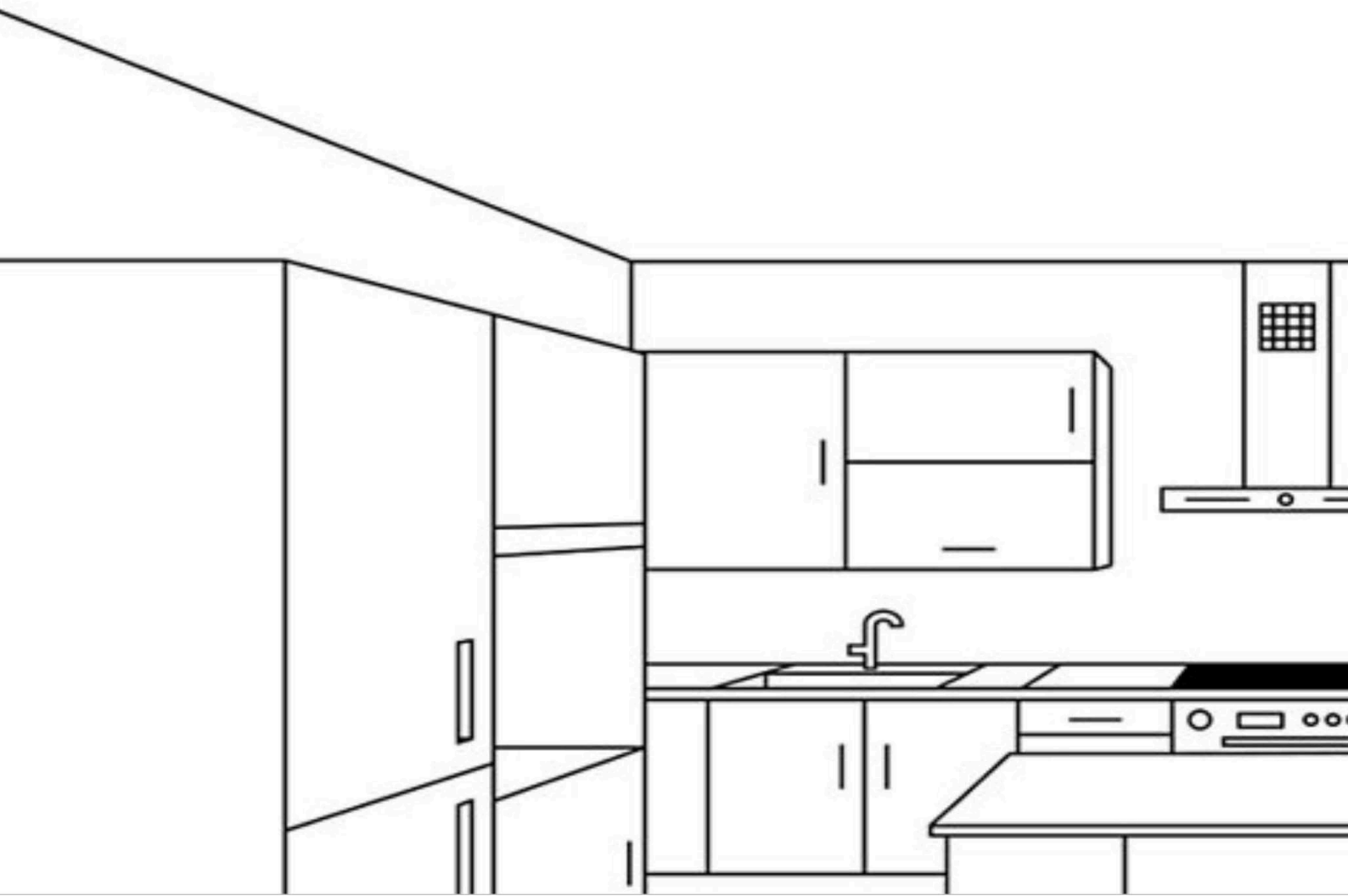

## METALLIC SERIES

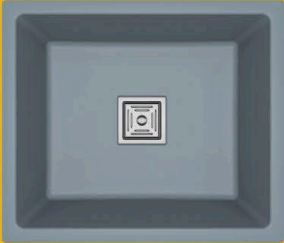

SLATE GREY

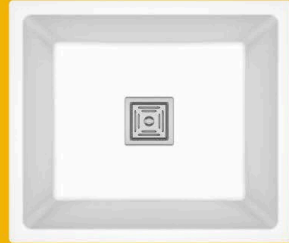

SNOW WHITE

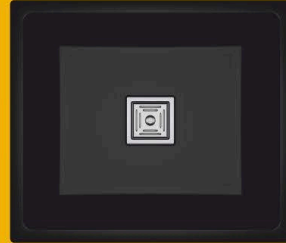

ZED BLACK



CHOCO BROWN

## GRANITE SERIES

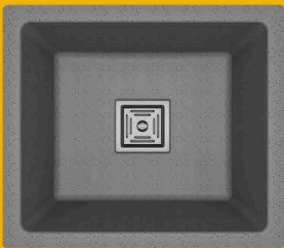

MAGIC GREY

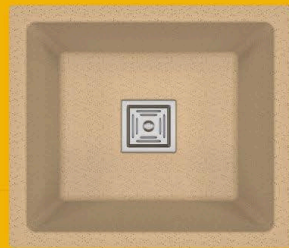

MAGIC IVORY

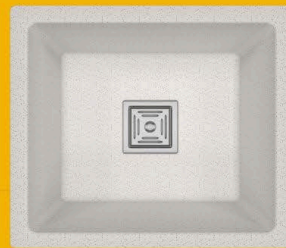

MAGIC WHITE

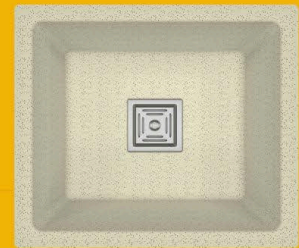

MAGIC CREMA

### Disclaimer:

- The Colours / Shade shown of sinks in this catalogue are purely illustrative and limited to printing process. Please refer actual sample before final selection.
- In case of any complaint, it should be brought to our Dealer notice before laying the sink.
- All sizes/prices are subject to change without prior notice.
- Please Refer MM size before Installation.
- All specifications are approximate and can vary in actual product. All Product shown is Identical and may vary from the actual product. This catalogue super seeds all previous catalogues.
- All products shown are not part of standard offering & props depicted are for aesthetics purpose only.
- Subject to Morbi (India) Jurisdiction.



# // Q STONEX

Elevate with Quartz Excellence

## Q STONEX SINK

MFG of QUARTZ KITCHEN SINK

Kempulse Industries  
LS No 352, Mota Kapaya, Kachchh,  
Gujarat, 370415  
INDIA

Contact: +91 8105256827

Email: [sales@kempulse.com](mailto:sales@kempulse.com)

[www.quartzstonex.com](http://www.quartzstonex.com)

